

SPECIFICATIONS SUBJECT TO  
CHANGE WITHOUT NOTICE

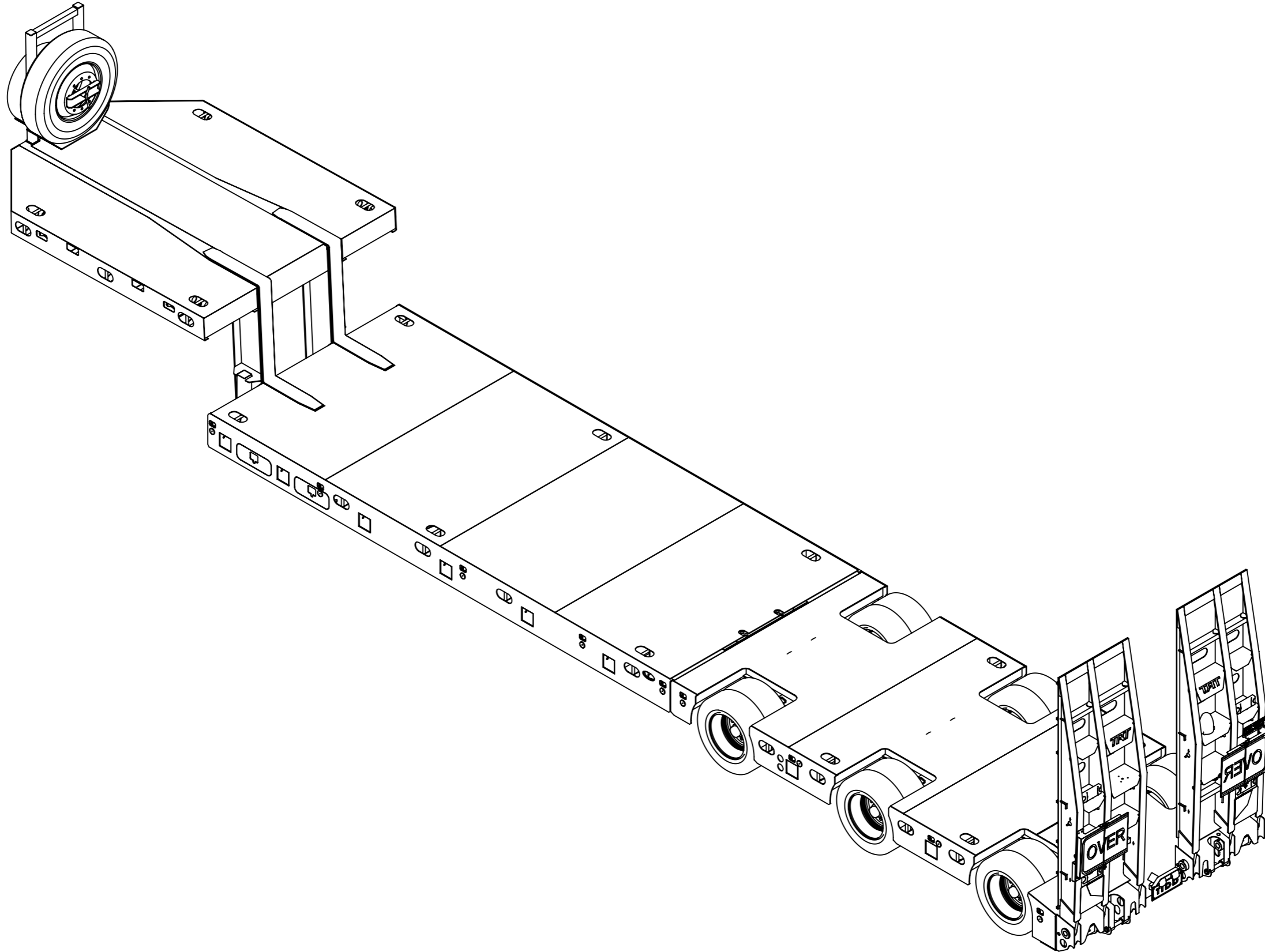

**TOLERANCE** : ± 0.5mm UNLESS OTHERWISE STATED  
**WIRE BUFF** ALL STEEL COMPONENTS PRIOR TO WELDING  
**WELDING**: ALL INFORMATION SHALL COMPLY WITH NZ/AS 1554:2000 PT 1 CATEGORY SP UNLESS OTHERWISE STATED AND SHALL BE WELDED TO A QUALIFIED PROCEDURE, BY A WELDER QUALIFIED FOR THE APPROPRIATE POSITION AND SUPERVISED BY A WELDING SUPERVISOR  
 THIS DRAWING IS © COPYRIGHT AND IS THE PROPERTY OF TIDD ROSS TODD LTD.  
 IT IS FURNISHED TO YOU FOR CONFIDENTIAL INFORMATION PURPOSES ONLY AND IS NOT TO BE DISCLOSED TO ANYONE ELSE OR USED FOR MANUFACTURING PURPOSES WITHOUT THE EXPRESS WRITTEN PERMISSION OF TIDD ROSS TODD LTD.

REV	DATE	COMMENT	NAME

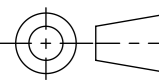

48 Maui Street  
 Hamilton  
 New Zealand  
 Phone +64 7 849 4839  
 Fax +64 7 849 3628  
 Email : trt@trt.co.nz  
 ISO 9001

NAME	DATE	TITLE:	REVISION
DRAWN DM	18/04/2018	3X4 EXTENDABLE LOW LOADER	A
CHK'D -	-	SHEET 1 OF 3	
APPV'D -	-	DWG NO. 150-A1 W	
DO NOT SCALE DRAWINGS IN mm's	<b>STATUS - M</b>	SCALE:1:40	

SPECIFICATIONS SUBJECT TO  
CHANGE WITHOUT NOTICE

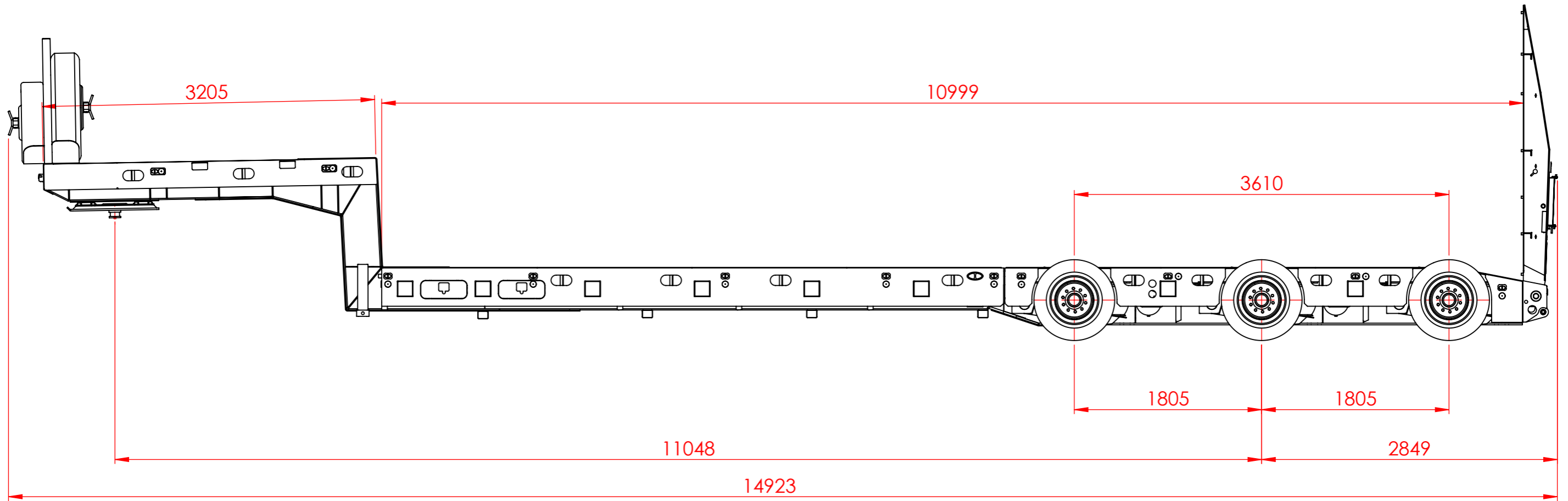
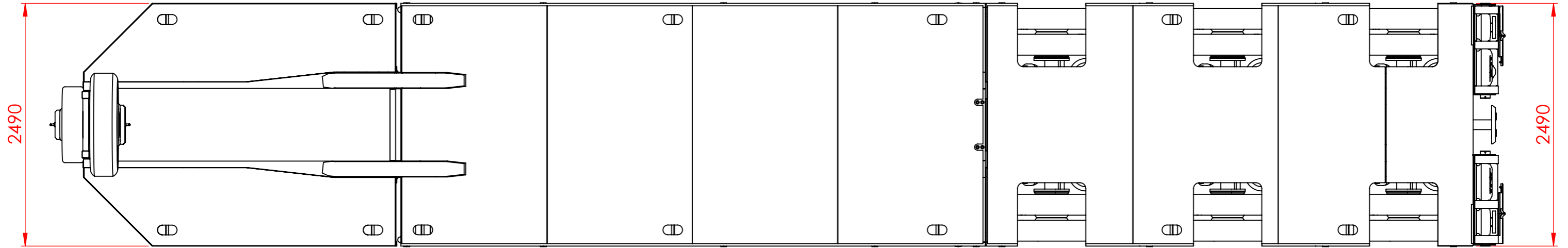

**TOLERANCE** : ± 0.5mm UNLESS OTHERWISE STATED  
**WIRE BUFF ALL STEEL COMPONENTS PRIOR TO WELDING**

THIS DRAWING IS © COPYRIGHT AND IS THE PROPERTY OF TIDD ROSS TODD LTD. IT IS FURNISHED TO YOU FOR CONFIDENTIAL INFORMATION PURPOSES ONLY AND IS NOT TO BE DISCLOSED TO ANYONE ELSE OR USED FOR MANUFACTURING PURPOSES WITHOUT THE EXPRESS WRITTEN PERMISSION OF TIDD ROSS TODD LTD.

REV	DATE	COMMENT	NAME

**WELDING:** ALL INFORMATION SHALL COMPLY WITH NZ/AS 1554:2000 PT 1 CATEGORY SP UNLESS OTHERWISE STATED AND SHALL BE WELDED TO A QUALIFIED PROCEDURE, BY A WELDER QUALIFIED FOR THE APPROPRIATE POSITION AND SUPERVISED BY A WELDING SUPERVISOR



**TIDD ROSS TODD LIMITED**

48 Maui Street  
 Hamilton  
 New Zealand  
 Phone +64 7 849 4839  
 Fax +64 7 849 3628  
 Email : trt@trt.co.nz  
 ISO 9001

NAME	DATE	TITLE:	REVISION
DRAWN	DM	18/04/2018	3X4 EXTENDABLE LOW LOADER
CHK'D	-	-	
APPV'D	-	-	
DO NOT SCALE DRAWINGS IN mm's		<b>STATUS - M</b>	SCALE:1:40
SHEET 2 OF 3		DWG NO. 150-A1 W	REVISION A

SPECIFICATIONS SUBJECT TO  
CHANGE WITHOUT NOTICE

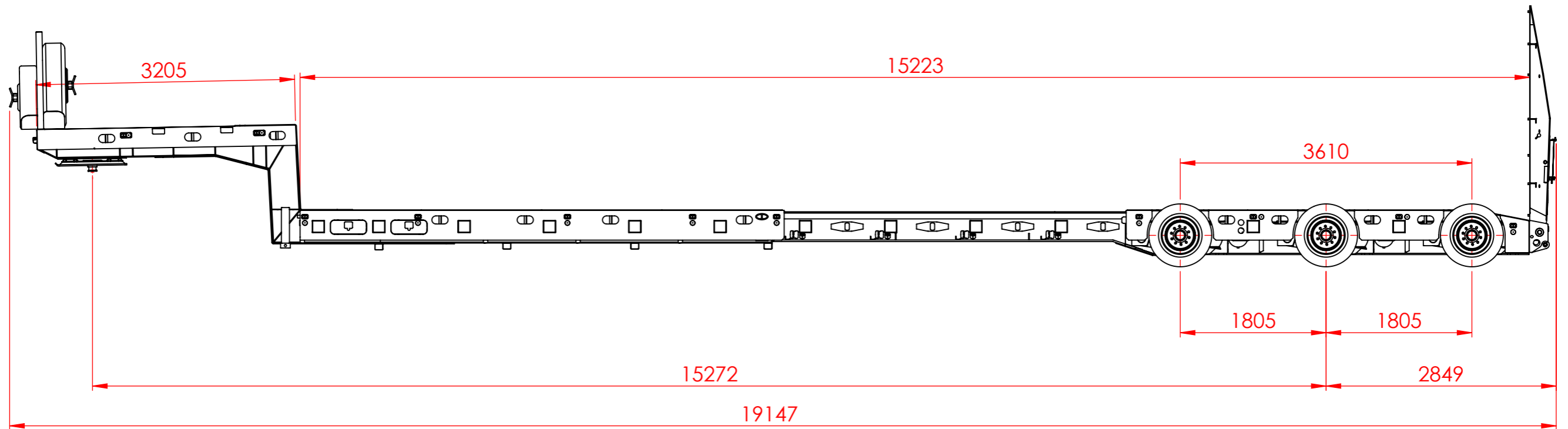
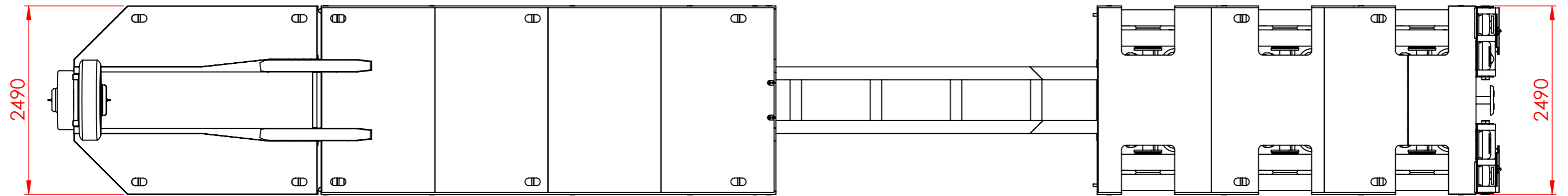

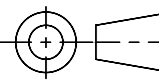
**TOLERANCE** : ± 0.5mm UNLESS OTHERWISE STATED  
**WIRE BUFF** ALL STEEL COMPONENTS PRIOR TO WELDING  
**WELDING**: ALL INFORMATION SHALL COMPLY WITH NZ/AS 1554:2000 PT 1 CATEGORY SP UNLESS OTHERWISE STATED AND SHALL BE WELDED TO A QUALIFIED PROCEDURE, BY A WELDER QUALIFIED FOR THE APPROPRIATE POSITION AND SUPERVISED BY A WELDING SUPERVISOR  
 THIS DRAWING IS © COPYRIGHT AND IS THE PROPERTY OF TIDD ROSS TODD LTD.  
 IT IS FURNISHED TO YOU FOR CONFIDENTIAL INFORMATION PURPOSES ONLY AND IS NOT TO BE DISCLOSED TO ANYONE ELSE OR USED FOR MANUFACTURING PURPOSES WITHOUT THE EXPRESS WRITTEN PERMISSION OF TIDD ROSS TODD LTD.

REV	DATE	COMMENT	NAME



**48 Maui Street**  
**Hamilton**  
**New Zealand**  
 Phone +64 7 849 4839  
 Fax +64 7 849 3628  
 Email : trt@trt.co.nz  
 ISO 9001

	NAME	DATE
DRAWN	DM	18/04/2018
CHK'D	-	-
APPV'D	-	-

TITLE:		REVISION	
3X4 EXTENDABLE LOW LOADER		A	
SHEET 3 OF 3	DWG NO.	150-A1 W	
DO NOT SCALE DRAWINGS IN mm's	<b>STATUS - M</b>	SCALE:1:55	